

Product Profile

XPRESS Creasing Matrix delivers reliability and accuracy. Xpress consists of precision engineered plastic shoulders mounted on a steel film base with a perfectly registered locator. This original style of creasing system provides benefits in time and cost based on both the reliability delivered by steel base durability and accuracy derived from the high quality manufacture. Available in standard, large, off-centre and reverse bend sizes, Xpress delivers reliable and accurate creasing every time.

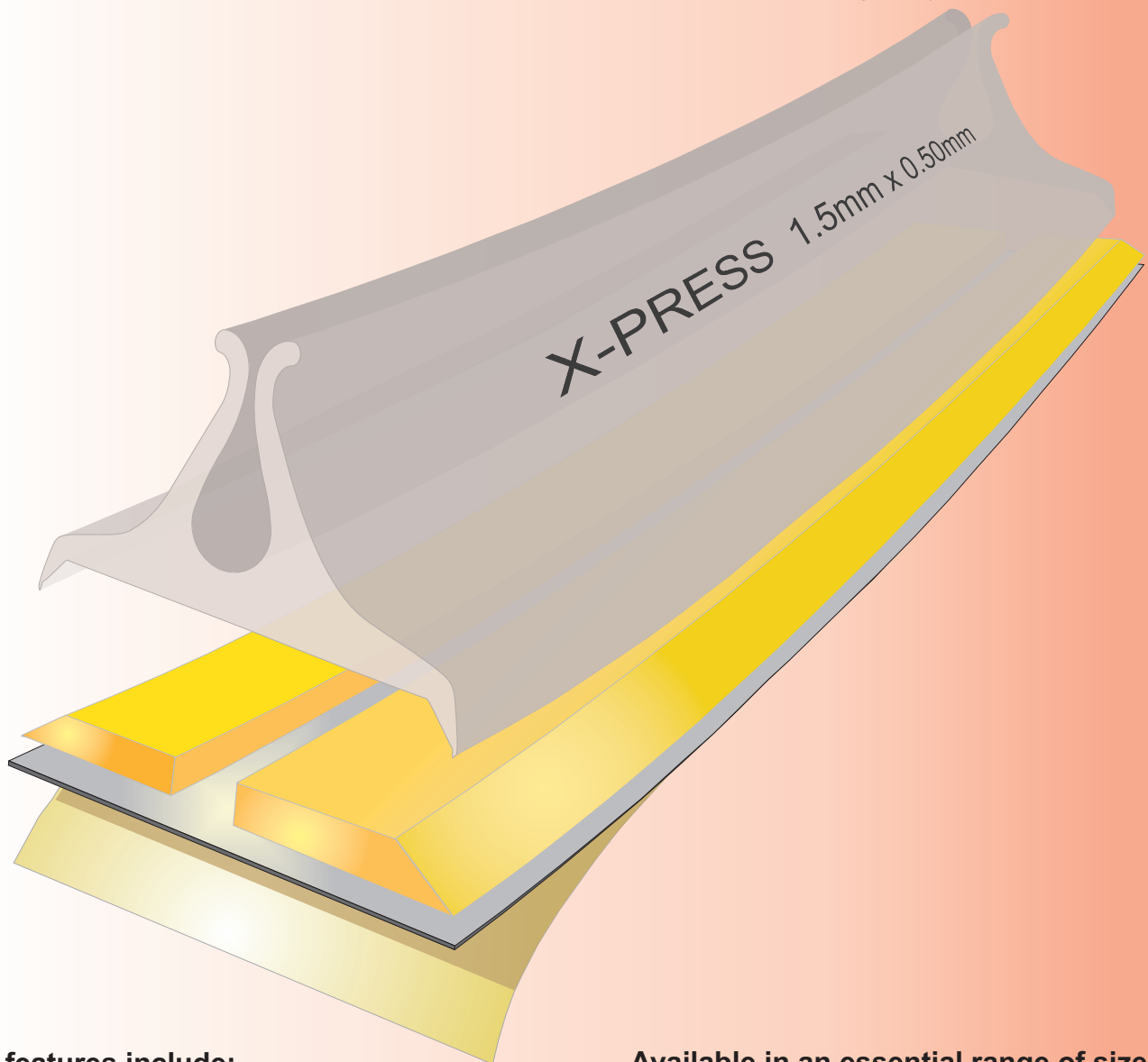

Key features include:

- Precision engineered plastic shoulders are extremely accurate and durable
- Steel film base to enhance durability and accuracy
- Perfectly registered locator ensures accurate and high quality creasing
- Original style of creasing system
- Steel Base and high quality manufacture deliver benefits in time and cost due to longer runs
- All profiles are individually colour coded and labelled for easy reference and to minimise the risk of mixing sizes during make ready (see separate charts)

Available in an essential range of sizes:

- STANDARD
- LARGE
- OFF-CENTRE
- REVERSE BEND

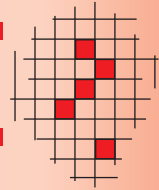

Standard Matrix

Plastic Counter - Steel Base

Precision engineered plastic shoulders on micro thin steel base with perfectly registered locator.

Standard sizes of X-press have 36 strips of 700mm in each box.

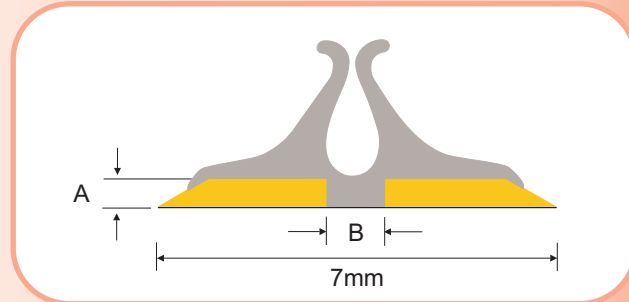

Colour Code	A	B	Board Thickness		Board Wt (gms/m ²)	Order Code
			(microns)	(0.001")		
Platinum	0.40	x 0.50	50-100	2-4	50-100	050-040
Orange	0.40	x 0.80	50-100	2-6	50-150	080-040
Beige	0.40	x 1.00	100-200	4-8	100-175	100-040
Pale Blue	0.40	x 1.30	300-400	12-16	225-275	130-040
White	0.45	x 1.30	325-400	13-16	240-270	130-045
Black	0.55	x 1.30	325-450	13-18	240-300	130-055
Apple Green	0.45	x 1.50	375-450	15-18	260-300	150-045
Yellow	0.50	x 1.50	425-500	17-20	290-335	150-050
Rosewood	0.70	x 1.50	475-550	19-22	350-365	150-070
Powder Blue	0.55	x 1.70	500-550	20-22	335-365	170-055
Purple	0.60	x 1.70	525-600	20-24	350-400	170-060
Green	0.60	x 1.90	525-600	20-24	350-400	190-060
Ash Grey	0.80	x 1.90	550-600	22-24	365-400	190-080
Burgundy	0.65	x 2.10	575-650	23-26	385-435	210-065
Pink	0.80	x 2.10	600-700	24-28	400-465	210-080
Red	0.70	x 2.30	625-700	25-28	420-465	230-070
Blue	0.80	x 2.70	700-800	28-32	465-535	270-080

Standard locators are suitable for rule sizes 2-3.

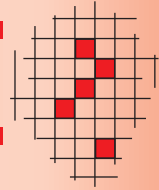

Large Matrix

Plastic Counter - Steel Base

X-press Crease Large sizes are suitable for thicker board sizes and have 21 strips of 700mm in each box.

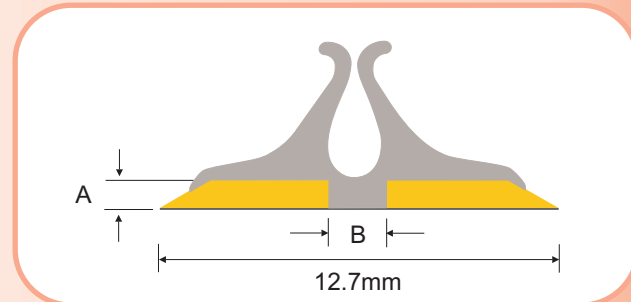

Colour Code	A	B	Board Thickness		Board Wt (gms/ m ²)	Order Code	Rule Size (points)
			(microns)	(0.001")			
Brown	1.00	3.00	800-1000	32-40	535-665	300-100	2/3, 3/4
Yellow	1.30	3.00	800-1000	32-40	535-665	300-130	3/4
Grey	1.20	4.00	1000-1300	40-51	665-800	400-120	2, 2/3, 3/4, 4, 6
Green	1.60	4.00	1000-1300	40-51	665-800	400-160	4, 6
Black	1.50	5.00	1300-1500	51-60	800-900	500-150	3/4, 4, 6
Red	2.00	5.00	1300-1500	51-60	800-900	500-200	4, 6
Cream	1.70	6.00	1500-1700	60-67	900-1000	600-170	4, 6
Blue	2.50	6.00	1500-1700	60-67	900-1000	600-250	4, 6

Please specify rule size when ordering.

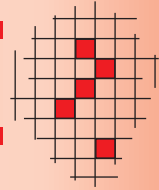

Off Centre Matrix Plastic Counter - Steel Base

Specially engineered for jobs that require two creases close together, X-press Off-Centre is placed on the creasing rules with the narrow sides adjacent enabling the smallest possible distance between creasing centres to be calculated as follows:-
 Distance Centre to Centre (C) = 2 x shoulder width (i.e. 1.5mm) plus creasing width required (B).

X-press Off-Centre has 36 strips of 700mm in each box.

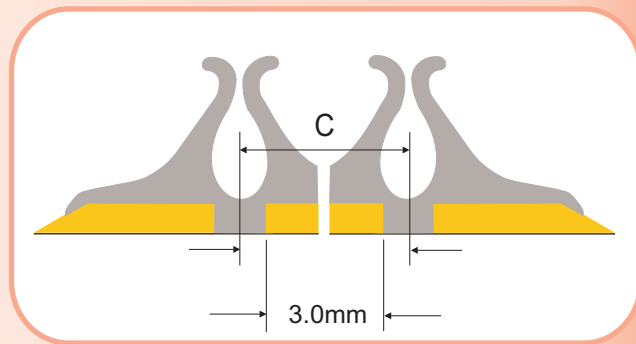
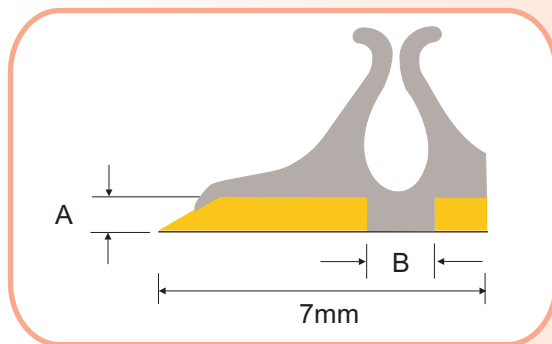

Colour Code	A	B	Board Thickness		Board Wt (gms/m ²)	Order Code
			(microns)	(0.001")		
Beige	0.40	x 1.00	100-200	4-8	100-175	310-040
White	0.45	x 1.30	340-410	13-16	240-270	313-045
Yellow	0.50	x 1.50	440-500	17-20	290-335	315-050

Locators are suitable for rule sizes 2-3.

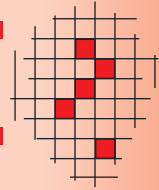

Reverse Bend Matrix Plastic Counter

Specially engineered to produce crease when cutting from the reverse side, the locator on X-press Reverse Bend fits between the two rules to perfectly register the matrix. We recommend using the creasing rules reversed in the cutting die.

Strips are 700mm long and standard sizes up to 2.7mm locator widths (dimension Y in diagram) have 36 strips in each box and large sizes with locator widths over 4.0mm have 21 strips per box.

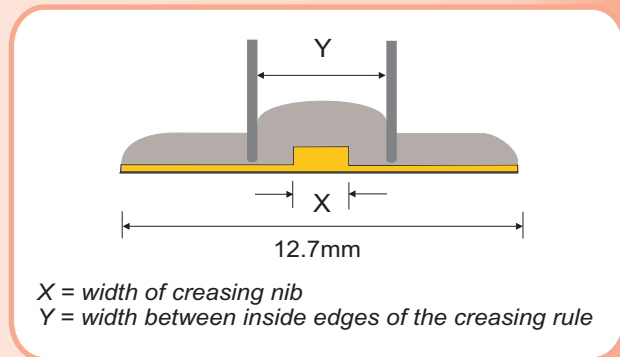

Colour Code	X	Y	Board Thickness		Board Wt (gms/ m ²)	Order Code
			(microns)	(0.001")		
Black	0.70	x 2.70	350-425	15-18	260-300	270-007
Orange	0.80	x 2.70	400-450	16-18	280-300	270-008
Beige	1.00	x 2.70	400-475	16-18	280-310	270-010
White	1.20	x 2.70	425-500	16-20	280-325	270-012
Green	1.50	x 4.00	450-550	18-22	300-365	400-015
Yellow	1.50	x 5.00	500-600	20-24	350-400	500-015
Purple	2.00	x 5.00	800-900	32-36	535-600	500-020
Blue	1.50	x 6.00	550-650	22-26	365-435	600-015
Pink	2.00	x 6.00	900-950	36-38	600-650	600-020
Brown	3.00	x 6.00	950-1050	38-42	650-700	600-030

X-press Reverse Bend is suitable for all rule point sizes.